

Liversidge Research Lecture

No. 8
1950

ENERGY TRANSACTIONS IN HOMEOTHERMIC ANIMALS

HEDLEY R. MARSTON, F.R.S.



The Royal Society of New South Wales



Hedley Ralph Marston

Hedley Ralph Marston 1900-1965

This photograph is reproduced by permission of the Australian
Academy of Science

HEDLEY RALPH MARSTON 1900-1965

Hedley Ralph Marston was born on 26 August 1900 at Bordertown, South Australia. He was educated at the Unley District Primary and High Schools; one of his fellow pupils there was Mark Oliphant (later Sir Mark). Upon leaving school he took a temporary position as laboratory assistant at the South Australian Government Laboratory for Pathology and Bacteriology. In 1917, after further study of natural science, he obtained a scholarship to study at the South Australian School of Mines that he attended from 1917-1920. He then took courses in physics and chemistry at the University of Adelaide as a 'non-graduating student' and became a part-time demonstrator in chemistry under H.H. Finlayson. During the period 1922-28 Marston was a demonstrator in the Biochemistry Department, which at that time was headed by Professor T. Brailsford Robertson. In 1923, again as a non-graduating student, Marston obtained a first-class pass in the final Honours class in physiology and biochemistry. In fact, he never did graduate with a B.Sc. degree, and remained without a conventional qualification; his first degree was an Honorary D.Sc. awarded by the Australian National University in 1957.

In 1927 he was appointed as a part-time Biological Officer by the Council for Scientific and Industrial Research (CSIR) in connection with Robertson's studies of animal nutrition in the Department of General Physiology, University of Adelaide. Later in 1927, when Robertson became Chief of the Division of Animal Nutrition of CSIR, a laboratory was built in the grounds of the University, and in 1928 Marston became a full-time CSIR staff member. When Robertson died in 1930, Marston became Acting Chief, until early 1931; he was also Acting Chief from mid-1933 until mid-1935, when this Division became part of the Division of Animal Health. Marston then became Officer-in-Charge of the Nutrition Laboratory of that Division. In 1944 this laboratory was designated as the Biochemistry and General Nutrition Division of CSIR with Marston as Chief, the position he held for the rest of his life.

The research carried out and directed by Hedley Marston at what became the Commonwealth Scientific and Industrial Research Organisation (CSIRO) in 1949, may be summarized as follows:-

1. The relation of protein and sulfur metabolism in sheep to wool production
2. Microbial conversion of cellulose to volatile fatty acids in the sheep rumen
3. The energy balances of sheep under Australian husbandry conditions
4. Studies of phosphorus requirements of sheep
5. The very important work on cobalt-deficiency in sheep and cattle in some areas of Australia - the importance of vitamin B12. The patenting by CSIRO, under Marston's name, of a method of administering cobalt to ruminants
6. The importance of copper as a trace element in relation to sheep metabolism and wool quality.

During the Second World War (1939-1945) the work of the Adelaide laboratory was broadened to include aspects of human nutrition.

Honours and Awards

- 1938 FACI (Fellow of the Australian Chemical Institute)
- 1949 FRS
- 1950 Liversidge Research Lecture, Royal Society of New South Wales
- 1954 FAA (a Foundation Fellow of the Australian Academy of Science)
- 1957 D.Sc., *honoris causa*, Australian National University
- 1958 Mueller Medalist, ANZAAS
- 1959 D.Sc., *ad eundum gradum* , University of Adelaide

Biographical Sources

1. Synge, R.L.M., 'Hedley Ralph Marston 1900-1965: elected F.R.S. 1949,' *Biographical Memoirs of Fellows of the Royal Society*, 1967, **13** , 267-293.
2. Underwood, E.J., 'Hedley Ralph Marston', *Records of the Australian Academy of Science*, 1967, **1**, (2), 73-86.

Scientific Publications by H.G. Marston

A list of the 59 scientific publications of H.G. Marston and his CSIRO collaborators is appended to each of the articles (1) and (2), given above under Biographical Sources.

ENERGY TRANSACTIONS IN HOMEOTHERMIC ANIMALS*

HEDLEY R. MARSTON, F.R.S.

*C.S.I.R. Division of Biochemistry and General Nutrition, University of Adelaide,
South Australia*

Mr. President and Members of the Royal Society of New South Wales,

I thank you for the honour of being selected by you to be the Liversidge Research Lecturer for 1950. I had never an opportunity to meet Archibald Liversidge, but I knew of his devotion to Science, and so was gratified when this opportunity made it possible for me to help carry out the desires expressed in his last testament. In this you will recall, Liversidge, with deep insight, set down the reference that ". . . the lectures shall be such as will *encourage research and stimulate the lecturer* and the public to think and acquire new knowledge by research, instead of merely giving instruction in what is already known . . ." Your lecturer has been stimulated in the course of the preparation of this discourse for you: if what it contains entices any one of you to use his special skill to render more clear the chemical reactions that are responsible for energy transfer in living organisms, the hopes of Liversidge will be met.

An exhaustive discussion of the field of knowledge that it would be desirable to cover before we might be quite ready to consider what is now known of the chemical reactions involved in the energy transactions of living processes is not for this occasion, so I trust I shall be forgiven if the treatment of the subject lacks the nicety of balance which may have been achieved had the facts we have at our disposal justified more precise generalization.† But we shall, no doubt, occasionally catch a glimpse, however faint, of the general laws of energy exchange that operate in living material, and thus be encouraged to add to the pattern of knowledge that is already taking shape.

In the somewhat dismal prospect revealed by Clausius' conclusion that our world is ever moving towards a state of maximum entropy, there is one bright spot. Photosynthesis, by those autotrophic organisms which bear chlorophyll, converts a part of solar radiation into chemical energy of high potential and so initiates a series of reactions which create order out of the monotony of the more probable state that atoms of hydrogen, oxygen, carbon, nitrogen, etc., have long since assumed in the earth's atmosphere and hydrosphere. The continual renewal of life brought about in this way is a backwater contrary to the flow towards the equilibrium implied in maximum entropy; but this state is transient - chemical reactions of living processes are poised precariously in a medium of oxygen which, although for a while their main driving force, ultimately consumes the organism that renders them possible, to degrade its ordered substance again to Nature's more probable

* The Liversidge Research Lecture delivered November 15th, 1950. Reproduced by permission of the Royal Society of New South Wales from *J. Proc. Roy. Soc. N.S.W.*, 1950, **84**, 169-183.

† I hope to be forgiven also for failing to mention the names of those responsible for the great volume of experimental work drawn on during the preparation of this lecture. To acknowledge even briefly those whose contributions have given form to this subject would call for a catalogue of names that would increase many times the length of this paper.

state. Transient and somewhat feeble this contra current, but it flows to a complexity of form in which stirs thought, the mirror in which Nature views herself. We are tempted to dwell here and ask questions. Uncertain ground this, however, and perilously near the siren call of first causes. So on this occasion let us avoid it and devote our attention to phenomena - nowise less alluring to the curious - which may be interpreted through experimental enquiry.

I propose to recall for you some of the phenomena associated with the overall energy transactions that take place under conditions of relatively constant temperature in the tissues of homeothermic animals; to seek with you to learn something of the efficiency with which these proceed; and then to view our findings in the light of what is now known of the chemical reactions of intermediary metabolism that give rise to the free energy utilized in the process of living.

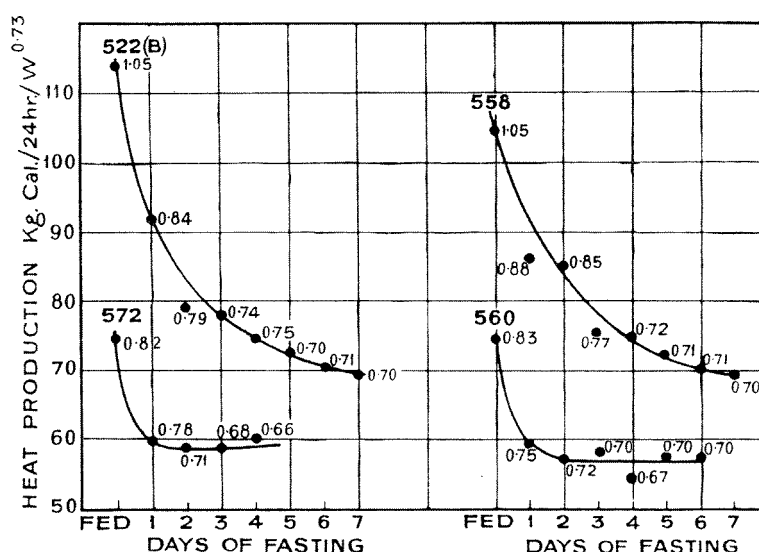

FIGURE 1. The fall in the rate of heat production that supervenes on fasting is shown by the performance of four sheep, of which two, Nos. 522B and 558, were fasted after three months on a very high level of feeding, and two, Nos. 572 and 560, after a similar period on rations which provided sufficient energy to meet only 50 per cent. of their energy requirements.

The gradual fall in the rate of energy expenditure of Nos. 522B and 558 towards the asymptote of the basal level is typical of well fed ruminants; the slow recession being due to the buffer effect of the voluminous rumen contents, which continues to ferment and so to provide assimilable nutriment to the animal for several days after the beginning of fasting. As carnivores and mixed-feeders rapidly digest and assimilate their food, the enhanced rate of heat production brought about by the heat increment of the absorbed nutriment subsides within 12-18 hours after feeding, and so the recession to the basal level is precipitate. Subsequent to reaching the basal level, the rate of heat production of the resting animal remains unaltered for a considerable period.

Sheep Nos. 572 and 560 were already in a state of malnutrition when the observations were commenced. As they were fasted from a low level of food intake, the residual food in the rumen was small, and fermentation was complete in 48 hours, and so the rate of heat production in these fell more rapidly to the low "basal" level, which is a consequence of inanition.

The respiratory quotient of each animal during the 24 hours over which its heat output was estimated is reported at each point on the graphs.

It is not my intention to pause long in the dawn of the modern era of nutritional physiology, but our thesis will be better founded if we recall Antoine Lavoisier's last great

contribution to science - his discovery of a relationship between the work performed by an animal and the oxygen it consumes - for this was indeed the sunrise. Perusal of the memoir in which Lavoisier describes the experiments that led to these conclusions still quickens the pulse, for he so clearly delights in setting down his ideas. Here, in a manner quite foreign to his earlier writings, he exults in his argument, then, to savour it, pauses a while to philosophize, akin in style to that incorrigible moralizer Joseph Priestly; soon to take up the threads again to discuss the effects of the ingestion of food on oxygen consumption - which incidentally will be our main concern - finally to end with an excursion into politics, pleading men to caution in the threatening storm of revolution, as if in anticipation of his own fate. This, the last and greatest of his memoirs to the Academy, contains his confession of faith; in it he sets down two essential conditions for the advancement of knowledge - freedom of thought and the quietness of the laboratory. In the light of his experiments he had beheld the vista and declared " *La vie est une fonction chimique* ".

Before we consider the classical theories of energy metabolism, and attempt to set them more securely in the framework of existing biochemical knowledge, we should recall the main phenomena associated with heat production in homeothermic animals. At this stage our concern is neither with the energy expended in voluntary muscular movement nor with the processes that are influenced through nervous and hormonal mechanisms when, in a cold environment, radiation exceeds the amount of heat liberated in the normal course of the animal's metabolism. We seek at this juncture to learn something of the rate of energy expenditure necessary merely to sustain life in the homeothermic animal, and so are at pains to eliminate as many variables as possible.

When the increased heat production that supervenes on consumption of food has subsided, a warm-blooded animal, at rest in a neutral thermal environment, produces heat at a rate which for some days is tolerably uniform. During prolonged fasting - while the organism is virtually living at the expense of its own tissues - this basal rate of heat production recedes very gradually with the onset of inanition, to increase abruptly, as a symptom of the cataclysmic disorganization of the metabolic processes, immediately prior to death.

Some of the earliest observations, made over 100 years ago, showed clearly that this overall cost of living is not a direct mathematical function of the animal's size but is nearly proportional to its body surface. Literal acceptance of the Surface Law which was formulated from this observed relationship has been responsible for no little confusion. The search for a parameter to facilitate comparison of the metabolic behaviour of animals of different sizes was influenced by the implication that radiation from the body surface determines the basal rate of heat production. In consequence, elaborate measurements were made of the areas of body surfaces in order to relate them to body weights so that - questionable logic this - energy metabolism might be related to surface areas computed from body weights. All this in search of a chimera, for any generalization based on the assumption that equal areas result in equal heat losses is precluded by the widely different capacities of different parts of the body surface to radiate heat. The Surface Law, in so far as it suggests a causal relationship between the physical surface of an animal and its basal rate of heat production, is untenable.

There is, however, no question that basal metabolism varies exponentially with body weight. In homeothermic animals a relationship of this sort is clearly essential. A few simple calculations of heat exchange will suffice to indicate the necessity for the relatively

great differences between the rates at which heat is produced in small and large animals. A mouse, for instance, with a basal rate of heat production per unit weight identical with that of an elephant could not live as a warm blooded animal in a temperate climate unless - strange fancy this - it were clothed in an envelope some 30 cm. thick of material with the same specific insulation as fur; or conversely, an elephant with a metabolic rate per unit weight identical with that of a mouse could not exist in its native habitat without a radiator

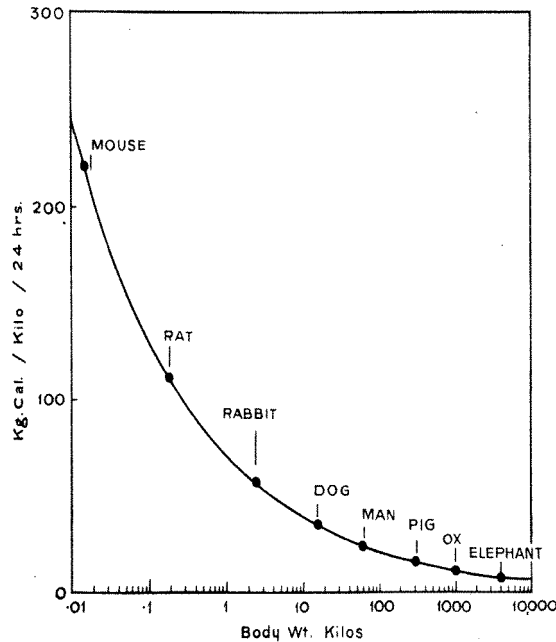

FIGURE 2. - The relationship between body weight and the rate of heat production of homeothermic animals under basal conditions is plotted. The points are mean values of critical determinations. The logarithmic scale employed for the ordinate of body weights tends to obscure small deviations from the smooth curve, but there is no doubt of the overall exponential relationship.

of monstrous proportions. These are extremes in the phylogenetic scale, but within small limits of deviation the same exponential relationship holds for all homeothermic animals, of identical species and of different species, whatever their size.

Some such relationship could not have been other than a prime criterion which, in the course of Evolution, determined survival of the species. The precision with which Natural Selection has poised the rate of metabolism and has graded so nicely the subsidiary anatomical apparatus to fulfill its requirements of fuel and oxygen is a subject for wonder. All seems so perfectly ordered, as if one agency determines both the size and the metabolic rate of the animal; for in such close harmony we are led to seek a single variable. Our thoughts at once fly to hormonal balance within the organism, and particularly to thyroxine with its known profound effects on both heat production and metabolism of protein, and incidentally on growth and development. But to follow such thoughts at this stage would lead us to digress. We shall return to them later.

We may accept, then, that the energy costs involved in living under basal conditions vary exponentially with the weight of the animal. Observation of the metabolism of animals varying in size from that of a mouse to that of the elephant suggest that the rate of heat production by mature animals under basal conditions will not deviate far from $70 W^{0.7}$ Kg. Cal. per 24 hours, where W (Kg.) is the body weight of the fasting animal. As this is an empiric expression determined from well-observed experimental data, it implies no

causal relationships. It is subject to small intraspecific corrections for age, sex, etc., which factors are known to influence metabolic activities.

In these considerations of the overall heat production we are dealing with a summation of the rates at which heat is produced by a number of different organs which, having in the course of ontogenesis assumed distinct functions, might be expected,

TABLE 1.

Energy Dissipated by the Tissues of a 70 Kg. Man under " Basal " Conditions.

Tissue	Weight of Organ and (Proportion of Body Weight)	Oxygen Consumption of Organ Litres O ₂ / 24 hr. and (Proportion of Total Oxygen Consumption)	Heat Produced. Kg. Cal./24 hr./Kg. Tissue
Whole body	70 Kg. (100 per cent.)	356 (100 per cent.)	23.5
Heart	0.33 Kg. (0.47 per cent.)	37 (10 per cent.)	520
Kidneys	0.33 Kg. (0.47 per cent.)	31 (9 per cent.)	440
Liver	1.6 Kg. (2.3 per cent.)	115 (32 per cent.)	335
Brain	1.4 Kg. (2 per cent.)	68.5 (19 per cent.)	225
	3.66 Kg. (5.24 per cent.)	251.5 (70 per cent.)	
Rest of body (by diff.)	66.3 Kg. (94.7 per cent.)	105 (30 per cent.)	7.4
Muscles	29.5 Kg. (42 per cent.)	58.5 (16 per cent.)	9.2

a priori, to differ in their call for energy. Let us then examine the contributions made by individual organs to the overall heat production. A close estimate may be made of this from the rates of oxygen consumption and carbon dioxide formation, and these may be assessed directly from the rate of blood flow and the difference in composition of the arterial and venous supply to individual organs. The rate of heat production in the visceral organs is amazingly great. Under basal conditions, approximately 70 per cent. of the total heat production of man, for example, originates in the heart, kidneys, liver and brain, the

combined weights of which constitute little over 5 per cent of the total body weight (*vide* Table1). The relatively rapid rate of heat production by the heart is not surprising - the work entailed in circulating the blood of a man of 70 Kg. body weight, for example, accounts for approximately 45 Kg. Cal./ 24 hr., which from the overall heat production implies a mechanical efficiency of close to 25 per cent. And the kidneys have extraneous work to do. Here again there is nothing to astonish us until we compute the free energy change entailed in the transport of salts, urea and water between the blood plasma and the urine, and find that the osmotic work necessary for the secretion of urine amounts to little more than 1 per cent. of the energy liberated as heat by the kidneys. Thus in the kidneys as well as in the liver and, curiously, in the brain, relatively intense chemical work proceeds continually, even when the animal is fasting and at rest. The chemical activity within these organs under basal conditions accounts for about 60 per cent. of the total heat produced by the animal. In comparison, the energy necessary to sustain the skeletal muscles in a living condition is small, smaller in fact than is implied in Table1, because, even when at rest, postural tonus involves some work. Why then this comparatively great intensity of activity in the visceral organs? What are the reactions which expend fuel at such a rate? And what controls them so precisely?

Before we seek an answer to these questions we might with profit consider briefly the phenomena associated with the increased heat production that supervenes on feeding. Up to this stage our concern has been with the rate of heat production under conditions selected in attempt to ensure a minimum expenditure of energy. This basal rate, however, is not by any means a simple expression of the minimum rate of free energy expenditure

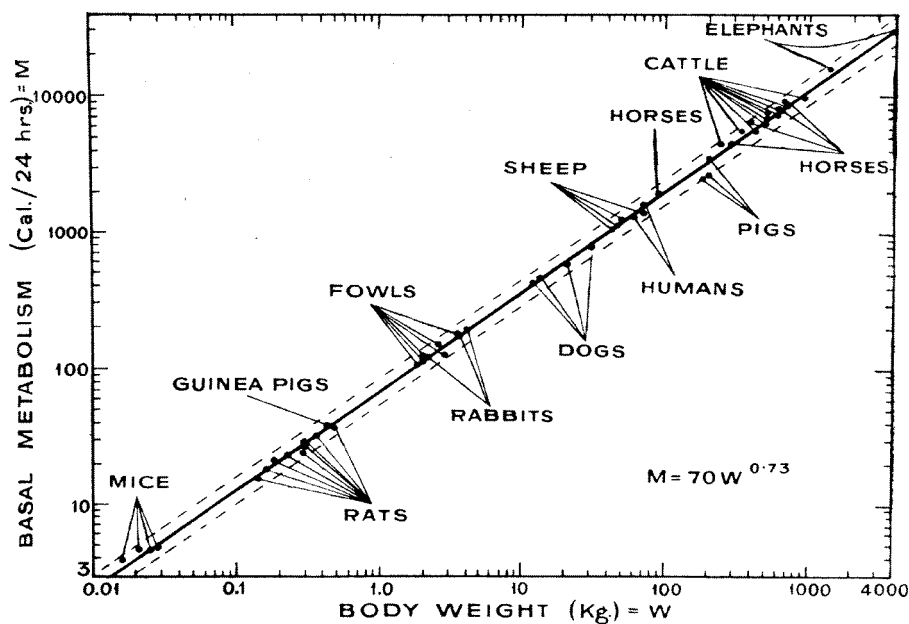

FIGURE 3. The exponential relationship between the body weight and the rated heat production of homeothermic animals under basal conditions is obvious from the above figure. The heavy line is that of the expression $M = 70W^{0.73}$ in which M is the rate of heat production in Kg. Cal./24 hr. and W is the body weight in Kg. The expression, derived empirically from observed data, is the best fit over a wide range of animals, the body weights of which extend from 20 gm. to 4×10^6 gm. The significance of the second figure of the exponent is doubtful. The broken lines are to indicate 10 per cent. deviation from the expression.

necessary to sustain life in the organism. Such an assumption would imply that the combustible energy of the materials drawn from the tissues of the fasting animal to support the living processes is 100 per cent. efficient for this purpose. Clearly, when considering energy transactions of this sort, we are dealing with two factors with the demands of the organism for energy and with the efficiency with which these demands may be met by the fuel assimilated from the food or drawn from the tissues. The term "basal metabolic rate" when applied to the heat production of an animal under defined "basal" conditions is thus misleading if it is interpreted to mean the minimum rate of energy demand, and it is particularly confusing if used as a base when assessing the capacity of a foodstuff to provide the animal with the energy necessary to support its living processes - lack of appreciation of this point has resulted in a half a century of controversy.

The fact that foodstuffs differ in their ability to induce extra heat production in the animal organism was recognized early in the study of energy metabolism, but the failure to realize that heat production is an incident, not an end, of metabolism, led, for a period, to the quite erroneous assumption that the function of a ration which would maintain a state

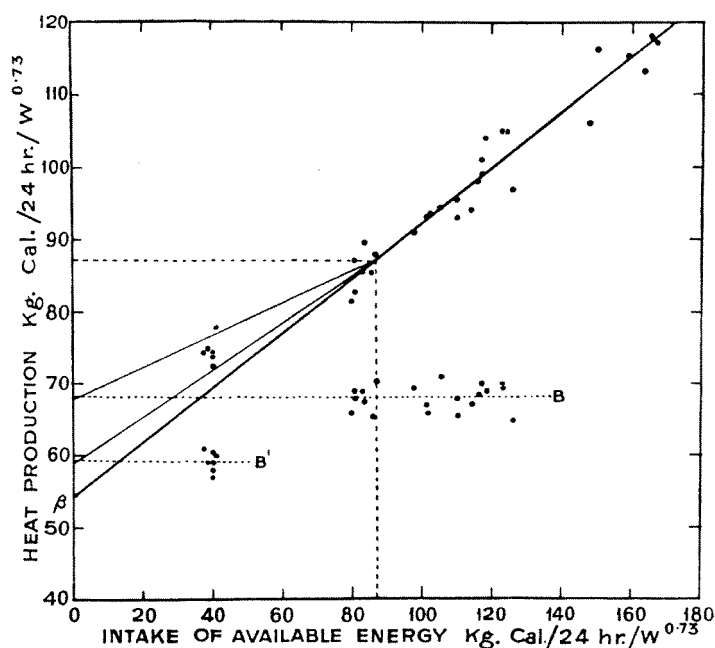

FIGURE 4. The relationship between the intake of available energy, I , from a fodder of constant composition, and the heat production, M , of sheep consuming it is plotted together with the "basal" fasting rate, B , and the inanition basal, B' . The available energy is the combustible energy of the fodder minus the sum of the combustible energy of the faeces, urine and of the methane which is a product of fermentation in the rumen. Above maintenance the heat produced by the animals is linearly related to the energy which becomes available from the rations. A constant proportion of the available energy - 37 per cent. of it from this particular fodder - is dissipated as heat without performing any useful work in the organism. This fraction is defined as "the heat increment". Extrapolation of the relationship to zero intake provides the term, β , which may be tentatively defined as "true basal heat production". This is 20 per cent. less than B , the rate of heat production of the resting animal under "basal" conditions, and implies that the energy provided by fuel drawn from the tissues is subject to a heat increment of 20 per cent. Thus, below maintenance, the slope of the relationship between the heat production and the energy available from the ration, alters. In this range, it is made up of two factors, the heat increment of the fodder and the heat increment of the tissue substances drawn upon to make up the energy deficit.

of energy equilibrium in an animal at rest in a neutral thermal environment was merely to provide the energy necessary for the maintenance of body temperature. There is, however, ample evidence to show unequivocally that only a fraction of the combustible energy of a maintenance ration contributes to the quota necessary to sustain life, and that the remainder merely adds to the heat production already sufficient to support body temperature.

The heat increment - that quota of the total energy available from a substance being metabolized which is dissipated as heat apparently without serving any useful purpose in metabolism - has been considered to vary with the level of feeding, for in the relationship between food intake and heat output, there is an apparent difference above and below the maintenance level. Below maintenance, however, when the available energy of the fodder is insufficient to provide for the energy requirements of the animal, the heat increment should be considered to be made up of two variables - the heat increment of the fodder and the heat increment of the tissue substance being drawn upon to make up the net energy deficit - and so, if these differ, the capacity of the fodder to provide useful energy would appear to alter abruptly as soon as energy equilibrium is established.

To illustrate these points let us consider, very briefly, the relationship between heat production and the intake of available energy, of sheep fed different quantities of the same foodstuff. It might be well to recall that the determination of the heat production of the ruminant entails special problems as by far the greater proportion of the energy that becomes available to the animal from the carbohydrates in its fodder is derived from simple fatty acids produced by fermentation in the paunch. The chemical changes involved in the

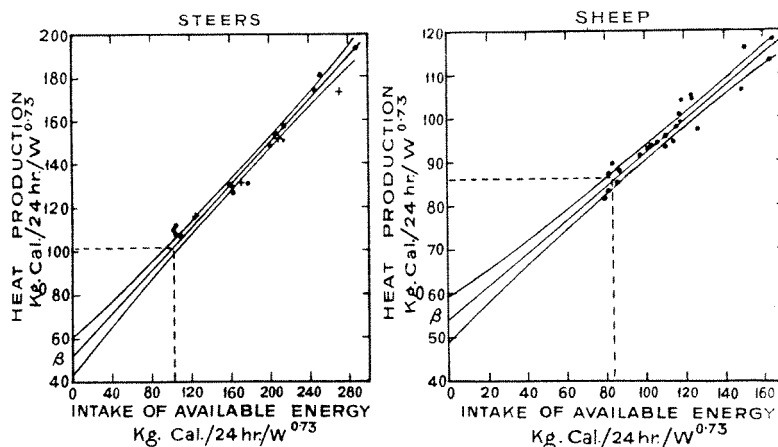

FIGURE 5. The apparent constancy of β , the point at which the linear relationship between heat production of an animal and the energy which becomes available to it from a fodder of constant composition, is illustrated by plotting two sets of independently observed data, one from observations on sheep and one from observations on cattle.

From the former, $\beta = 54.5 \text{ Kg. Cal. /W}^{0.73}/24 \text{ hr.}$ and from the latter $\beta = 51.8 \text{ Kg. Cal./W}^{0.73}/24 \text{ hr.}$, the difference being well within the standard error of the observations.

β is tentatively defined as "true basal rate of heat production" for the convenience of assessing the relative heat increments of the available energy from various fodders. The term "basal" does not imply that β is a measure of the minimum expenditure of energy necessary to support the living processes, but, in distinction to its more general use to define the exogenous conditions under which heat production is estimated, it connotes in this expression an endogenous constant common to the metabolism of all foodstuffs.

formation of these fatty acids through the activity of micro-flora are exothermic. The amount of heat dissipated during fermentation is approximately 6 per cent. of the combustible energy of the carbohydrates transformed. This quota of energy, like that of the heat increment, is valueless in the economy of the animal, other than when, in a cold environment, the amount of heat lost by radiation from the body surface is greater than that produced in the normal course of metabolism - under which circumstances, as a part of the overall heat increment, it spares, calorie for calorie, the energy that would be called upon merely to provide heat for the maintenance of body temperature. The heat production of the fed ruminant is thus the sum of the heat produced as an end result of metabolic processes of the animal itself and the heat evolved by the fermentive activity of the microorganisms of its alimentary canal.

When the whole of the animal's energy requirement is drawn from the fodder, there is no reasonable doubt that *the relationship between intake of available energy and heat production is linear*. The heat increment quota is *thus a constant proportion of the available energy* - in this particular instance 37 per cent. of the available energy is dissipated as heat in the chemical work necessary to prepare the absorbed nutrients for their entry into the chain of events through which, according to the supply and demand, they may either be launched into the energy-producing cycles or laid down as body substance (Fig. 4).

Extrapolation of this linear relationship to the heat production axis should allow a close estimate to be made of the overall amount of energy spent on the physiological requirements of living, uninfluenced by the heat increment of the materials oxidized to provide this energy. Thus the intercept, β , which we might call tentatively the "true basal requirement", is less than B, the actual heat production under basal conditions (Fig. 4), by the heat increment of the fuel drawn from the body substance - which from this estimate is close to 20 per cent. of the total heat dissipated during fasting.

Theoretically, within the limits of the $W^{0.7}$ exponential relationship between metabolic rate and body weight, the value of β should be identical for all homeothermic animals. There is only one set of independent observations in the scientific literature that provides suitable data for testing this hypothesis - that gathered from a fine series of critically conceived and meticulously observed determinations of the heat output of bullocks fed at different planes on rations of identical composition (Fig. 5). The intercept, β , at which the extrapolated regression of the heat production: available energy relationship cuts the heat production axis in this case indicates a value 51.85 Kg. Cal. / $W^{0.7}$ /24 hr. with a standard deviation of 3.38; the value of β derived similarly from experiments with the sheep is 54.56 Kg. Cal. / $W^{0.7}$ /24 hr. with a standard deviation of 2.30. What then is implied in this apparently constant figure? We may be better prepared in our attempt to answer this question if we recall something of what is known of the transformations involving energy exchange that take place in the course of intermediary metabolism.

We can be sure that free energy is not liberated in one burst when substrates are oxidized within the cell. The abrupt gradient in the passage of electrons towards oxygen that such an event would imply is lessened by an ordered series of reactions, guided through the maze of thermodynamic possibilities by interlinked specific catalysts that convey, by transphosphorylations, part of the free energy to compounds of relatively low molecular weight. From our present state of knowledge it appears not improbable that adenosine triphosphate assumes in this way the main role of carrier of energy within the cell, weaving between the sites where free energy is rendered available by respiration, and

the sites where chemical work is to be done, bearing in the resonance of its pyrophosphate group a versatile means of energy exchange for the performance of work within the cell - one is tempted to consider this resonance energy to be universal currency in living matter.

During respiration within the cell, three steps are now known to be capable of intervening between the liberation of two hydrogen atoms from the substrate and their final combination with oxygen - the stages marked successively by reactions with the co-enzyme pyridine-nucleosides, which occur at E'_0 , potentials about -0.32 v.; the reactions with the flavo-proteins, the protein complexes of d-ribityl 6:7-dimethyl-iso-alloxazine nucleoside, which occur about -0.6 v; and the reactions with the iron-bearing cytochromes, which occur about $+0.39$ v.

A path such as this, in which each pair of electrons is intercepted three times at

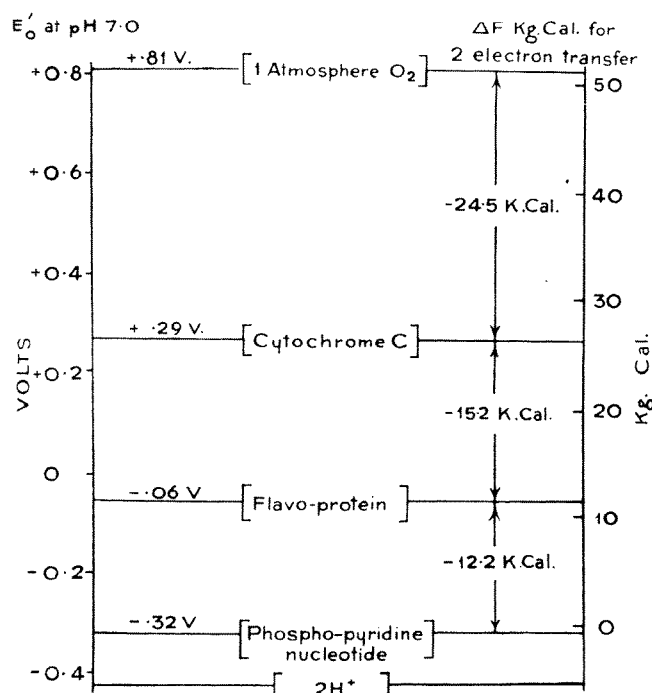

FIGURE 6. The free energy changes which would take place, when, during respiration within the cell, two electrons, set free by a dehydrogenating reaction, pass from the substrate, via phospho-pyridine nucleotide, flavo-protein and the cytochromes, to oxygen, may be assessed from the above figure.

The scale of oxidation-reduction potential E'_0 at pH 7.0, which is a measure of the free energy of the reactions involved, expresses, in volts, the difference of potential between the system at pH 7.0 and the normal hydrogen electrode (pH = 0). The signs and the zero of this conventional scale are thus consequences of the mathematical convenience in the selection of the normal hydrogen electrode potential as a reference point. The chemical potential, i.e. the relative tendency for electron flow, of these reactions decreases progressively as the potential of oxygen is approached.

The scale of free energy changes is derived from the relationship, $-\Delta f = nF \Delta E$, in which Δf = the change in free energy in Joules, n = the number of electrons involved, F = the Faraday, and ΔE = the potential difference in volts.

As the average resonance energy in pyrophosphate bonds, $\sim P$, is close to 12 Kg. Cal./mole, which is equivalent to approximately 0.25 volt per two electron transfer, four coupled reactions, each involving the production of one $\sim P$, are the thermodynamic limit if the above course is taken, one in the 0.26v. interval between phospho-pyridine nucleotide and flavo-protein, one in the 0.33v. interval between flavo-protein and the cytochromes, and a possible two in the 0.52v. interval between the cytochromes and oxygen.

intervals during their journey between the substrate and oxygen, would impose a thermodynamic limit to the number of coupled reactions which could be brought about. Thus, if this path were traversed, the transphosphorylating reactions which convert adenosine diphosphate to adenosine triphosphate, and thereby convey 12 Kg. Cal./mole in the resonance of the added pyrophosphate group, would be limited to four, for each atom of oxygen consumed. Available evidence suggests that only three such transfers are achieved. This would imply the dissipation as heat of 30 per cent. of the free energy liberated by each dehydrogenation - the remaining 70 per cent. being converted to resonance energy capable of performing work within the cell.

Some of you may recall that classical physiologists considered glucose "the preferred fuel" for the provision of energy to the organism. Let us, then, examine what is known of free energy changes which occur during oxidation of a glucose molecule within the cell. Glycolysis, you will agree, is now reasonably well understood to be a series of reversible reactions - extending in the animal organism between glycogen and pyruvic acid - through which glucose passes before its degradation product, pyruvic acid, enters the main energy-producing cycle where oxidation is completed. Admission of glucose into this chain of events necessitates its preliminary conversion to the Robinson ester, glucose-6-phosphate, by the intervention of the enzyme, hexokinase, and of adenosine triphosphate - a synthesis which entails the expenditure of 12 Kg. Cal./mole. from a pyrophosphate group to produce an ester-phosphate in which the resonance energy is in the vicinity of 3 Kg. Cal./mole. This priming reaction is thus exothermic and irreversible. Incidentally, the enzyme that affects it is now known to be subject to hormonal control - hexokinase activity

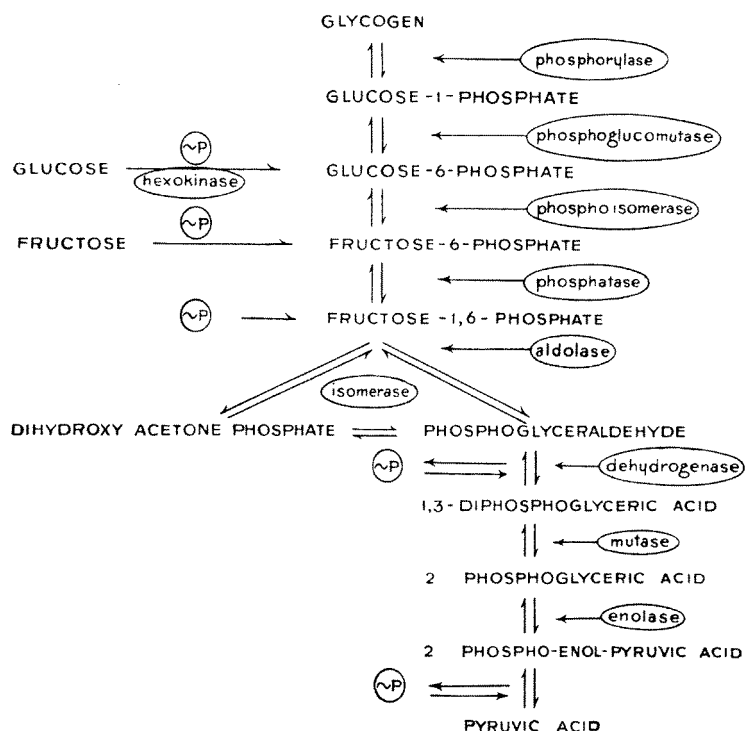

FIGURE 7. The probable course taken by glucose during glycolysis within animal tissues is indicated. The reactions between the links are reversible, the equilibria being influenced primarily by the concentration of adenosine triphosphate, the resonance energy of the pyrophosphate group of which is indicated by ~P. Conversion of glucose to glucose-6-phosphate in which form it is introduced into the glycolytic chain involves the expenditure of one ~P. The activity of hexokinase, which effects this priming reaction, is subject to hormonal control.

is apparently poised between the inhibitory influences of anterior pituitary and adrenocortical hormones and the stimulatory influences of insulin.

Once glucose is introduced into the glycolytic chain as glucose-6-phosphate its conversion through the Cori ester, glucose-1-phosphate, to glycogen, or its degradation via fructose-6-phosphate to the Harden-Young ester, fructose-1,6-phosphate - by means of phosphatase and the intervention again of adenosine triphosphate, at this stage to convey a recoverable unit of 12 Kg.Cal./mole - hence via the triose, phosphoglyceraldehyde, by dehydrogenation to 1,3-diphosphoglyceric acid, and then in turn through 2-phosphoglyceric acid and phosphoenol-pyruvic acid to pyruvic acid, is apparently a matter of equilibria, influenced by the relative concentrations of the reacting links, and of the availability of adenosine triphosphate. The resonance energy of two pyro-phosphate groups of adenosine triphosphate are expended in this series of changes and four are recovered. Thus, during the degradation of a glucose unit from glycogen through these reactions to two molecules of pyruvic acid, recovery in terms of the energy transferred to pyrophosphate groups - *i.e.* in currency expendable on work within the cell - is approximately 35 per cent. of the energy set free. The overall recovery of energy from the glycolytic reactions if glucose itself is the starting point is further reduced to approximately 20 per cent. by the cost of the priming phosphorylation.* But the major part of the potential energy of the glucose molecule (83 per cent. of it) is retained in the two molecules of pyruvic acid. The overall cost, then, in preparing glucose for its excursion into the tricarboxylic acid cycle is about 14 per cent. of its combustible energy. While considering these reactions in some detail I have perhaps tried your patience, but in recalling them, my purpose is to stress that there are considerable expenses in terms of energy which must be met before even "the preferred fuel" is converted to a form in which it may be launched into the cycle which apparently is the main convertor of energy in the living cell.

The reactions of the tricarboxylic acid cycle which are now known - and which possibly are the more important ones - are no doubt familiar to you all, so I shall not try your patience further by discussing them in any detail. However, it might be well to bear in mind that the path taken by electrons liberated from some of the dehydrogenations in the respiratory cycle remains obscure. But once launched into this cycle, the 2-carbon fragment from all metabolites might be expected to yield the same amount of energy to phosphate bond resonance.

When discussing the coupled reactions that take place after electrons are liberated by dehydrogenation of the substrate, we concluded that the highest efficiency of energy transfer, which may be expected if the course suggested were taken, could not exceed 80 per cent. and that from experimental evidence available, which implies three transphosphorylations for each atom of oxygen consumed in the tricarboxylic acid cycle, the efficiency would probably be closer to 70 per cent. If this estimate is correct, oxidation of the two moles of pyruvic acid would transfer to adenosine diphosphate approximately 360 Kg. Cal. as resonance energy in pyrophosphate groups. Complete oxidation of a molecule of glucose, then, would yield in this currency close to 55 per cent.

*Conversion of one mole of glucose to two moles of pyruvic acid involves a free energy change of -115 Kg. Cal. As the resonance energy, $\sim P$, of the pyrophosphate group of adenosine triphosphate is approximately 12 Kg. Cal., the net recovery of energy in this currency is about 24 Kg. Cal, the total recovery being 4 $\sim P$ and the expenditure 2 $\sim P$. The efficiency of the reaction in terms of resonance energy is thus approximately 20 per cent.

of the total free energy liberated - there is a net gain of 24 Kg. Cal./mole, it will be recalled, in the glycolytic reactions through which the glucose molecule is degraded to two molecules of pyruvic acid.[†] Thus it becomes evident that the net recovery of energy in a state capable of performing work within living tissues, falls far short of the total energy liberated during complete oxidation of a substrate.

Although fats take a course which, as yet, is not as well charted as the one taken by carbohydrates, their relatively low heat increment suggests that the higher fatty acids are launched into the reversible channels of metabolism with an efficiency comparable with that of glucose. Acetic acid - an important fuel for ruminants - is apparently a much more

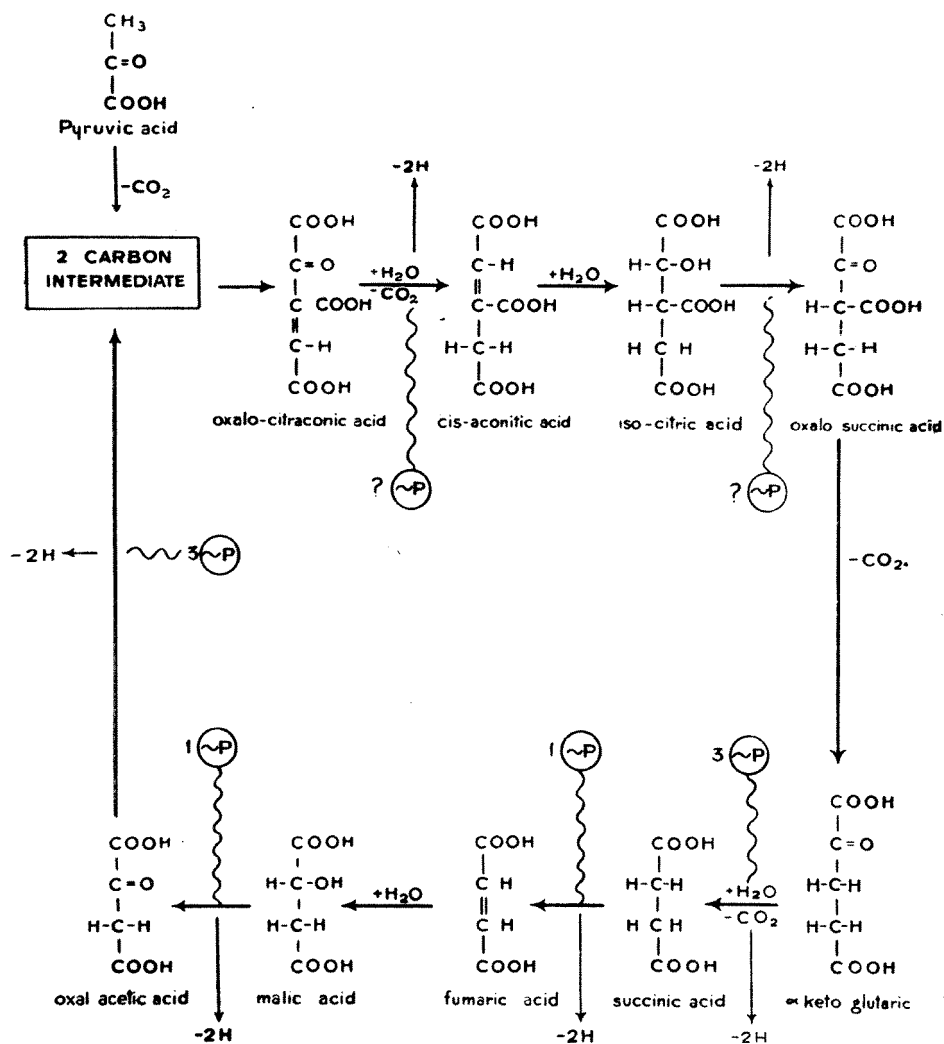

FIGURE 8. The known reactions of the tricarboxylic acid cycle through which respiratory dehydrogenation of many substrates is effected, are set out. Knowledge of these reactions has been achieved, for most part, from studies, *in vitro*, with tissue extracts and suspensions. The yield of ~P from the transphosphorylating reactions coupled to each stage of dehydrogenation is not yet clear. Experimental determination of the overall relationship between the amount of oxygen consumed and the yield of ~P during cellular respiration suggests that the production of 3~P is achieved at each stage. The thermodynamic limit would be 4~P. (*vide* Fig. 6.)

[†]Recovery of energy in the resonance of ~P (approx. 12 Kg. Cal./mole) on complete oxidation of a mole of glucose during respiration within the cell would be: from glycolysis, 2~P; and from oxidation of the two moles of pyruvic acid arising from glycolysis, 30~P, i.e., 384 Kg. Cal. from a total free energy change of 674 Kg. Cal.

expensive unit to launch into these channels, and for this reason is probably responsible for a major part of the relatively high rate of heat production in the fed ruminant. Propionic acid, which is formed along with acetic acid during fermentation of carbohydrates in the rumen, certainly has a materially smaller heat increment than that of acetic acid.

The heat increment of the available energy from protein is notoriously high. Here, however, we might expect the costs entailed in the formation and excretion of urea to be superimposed on the heat increments of the various fragments that arise from the deaminized amino acids, some of which take the metabolic course of the carbohydrates, some the course of the higher fatty acids, and some, like acetic acid, a much more expensive course. The costs of the chemical work necessary for the production of urea in the ornithine cycle, and for the osmotic work necessary for its excretion, must be discharged with the depreciated currency of resonance energy, and so are greater than those implied from the overall free energy change.

Hitherto I have refrained from employing the classical term "specific dynamic effect", which has been considered to be synonymous with "heat increment". I have avoided it because it implies that the increase of heat production which supervenes on the consumption of food is the result of a stimulus to metabolism - of an increase in the demands for energy by the tissues rather than a consequence of the costs entailed in the launching of the foodstuffs into channels through which these demands may be fulfilled. But the term and its implications may not lightly be dismissed when considering the effect that protein ingestion exerts on the heat production of animals, for it is conceivable that the dynamic equilibrium, which exists between the metabolic pool of amino acids and the tissue proteins, may be influenced by the amino acids arising from the ingested protein to an extent that might increase materially the expenditure of energy necessary to sustain protoplasmic structure.

Let us consider, very briefly, the energy transactions involved in this equilibrium, as they will serve, *inter alia*, to illustrate the relatively great losses of energy entailed in the performance of the chemical work in living tissues.

We have discussed the evidence which renders it probable that resonance energy of pyro-phosphate groups constitutes a most important currency for the performance of work in living tissues. The exchange rates for conversion of the energy liberated by respiration to this currency are obviously high, and - to continue the metaphor - its purchasing power in terms of chemical work is, more often than not, very low. For instance, the costs of synthesizing a peptide bond between two amino acids, which effects a free energy increase of about 3 Kg. Cal./mole, involves the expenditure of the whole of the resonance energy of the pyro-phosphate group of adenosine triphosphate, with the dissipation of 75 per cent. of it. Thus, synthesis of protein is a costly item in the economy of the organism; its efficiency in terms of the "preferred fuel" would not exceed 14 per cent., and, in terms of the fuel absorbed from the intestinal tract of ruminants, would be reduced further by the heavy losses involved in the high heat increment. A considerable amount of energy is clearly necessary to maintain the structure of protoplasm, for there is no doubt that the proteins in living cells are in constant flux and that their apparent steady state is but a reflexion of the relative rates of their degradation and resynthesis. From experiments in which N¹⁵-tagged [*sic*, ¹⁵N] amino acids were fed to humans and to rats there is eloquent evidence to indicate that the rate of protein turnover within the tissues of a homeothermic animal in a steady nutritional state, varies with the size of the animal. The ratio of the rates of protein synthesis per unit weight of the rat and of Man, estimated by

this means, is very close to 5:1 - practically identical with the relative rates of energy expenditure under basal conditions. We have already concluded (Table 1) that the heat production within the liver accounts for over 30 per cent. of the total heat production of Man under basal conditions. The rate of protein turnover in the liver of Man, assessed from the rate of loss of N¹⁵ from the blood-plasma proteins, which there is good reason to believe are produced in the liver and are in dynamic equilibrium with the liver protoplasmic proteins, bears a similar relationship to the overall rate of protein turnover. And the comparatively slow rate of protein turnover in the muscles is closely parallel to their basal heat production.

These relationships can hardly be fortuitous. They suggest that the mechanism which poises the basal rate of heat production might operate by influencing the rate of protein turnover. But, in so far as the latter may be estimated from exchange reactions, the energy cost of the syntheses necessary to preserve the tissue proteins in a steady state is not of the same order as the energy dissipation implied by the total heat production, even when the depreciated rate of the currency which effects these syntheses is accounted for. Nevertheless a common factor is suggested and we are impelled to seek it, for knowledge of the mechanism involved would greatly clarify the central problem of energy metabolism. Although many suggestive clues are available, no satisfactory explanation of the mechanism through which the rate of heat production is poised in homeothermic animals emerges from our present state of knowledge. It is not yet clear whether the nervous and hormonal agencies primarily responsible for the overall rate of heat production in the resting animal, exert their influence by altering the demands of the tissues for energy, or by altering the capacity of the fuel to meet these demands. The former influence could operate by controlling the relative rates of the hydrolyses and syntheses which determine the dynamic state of protoplasmic constituents. The latter could operate by controlling the series of equilibria between the links of the chain of intermediary metabolic events through which the universal currency of resonance energy is produced. Direct hydrolysis of adenosine triphosphate, by phosphatase, with the dissipation of its resonance energy without performance of chemical work could, in this way, alter very materially the rate of fuel consumption.

In both of these effects enzyme systems would be involved, and there is, already, unequivocal evidence in the case of hexokinase that some at least of the known hormones exert their profound physiological effects by influencing the activity of specific enzymes.

We might speculate without end, and progress little without experimental evidence, however, and we must leave this question unanswered, along with many of the others which have confronted us during our somewhat superficial survey of energy metabolism. But, the course towards the solution of some at least of the problems which have intrigued physiologists for more than a century is now clear enough to invite the curious: and it is perhaps not too much to expect that a great clarification of our knowledge of energy transactions in living matter will soon be achieved.

In our excursion this evening, we have failed to discover any clue which might help explain the high rate of energy dissipation that occurs in the brain. We may, however, be reasonably sure that this expenditure is not directly concerned with the elaboration of that tenuous secretion, thought. We may thus take heart, for this final product of the ephemeral turbulence in the universal flow towards maximum entropy apparently calls for extremely little expenditure of energy.

Gentlemen, I thank you for your attention. If I have provoked rather than diverted you, my task is fulfilled, for I have attempted to carry out the reference set down by Archibald Liversidge and conveyed to me in your invitation.

.....
Editorial note: There were no references cited.